

# The Empire Building Challenge

Partner Case Study



# Empire Building Challenge

A \$50 million NYSERDA investment to:

1. Accelerate private sector commitment and investment in carbon reduction, working with large portfolio owners.
2. Enable replication and scale across NY's existing large commercial/multifamily building stock.
3. Make NY a global hub for low carbon retrofits.
4. Drive innovation to meet the needs of NY's large commercial/multifamily building stock.

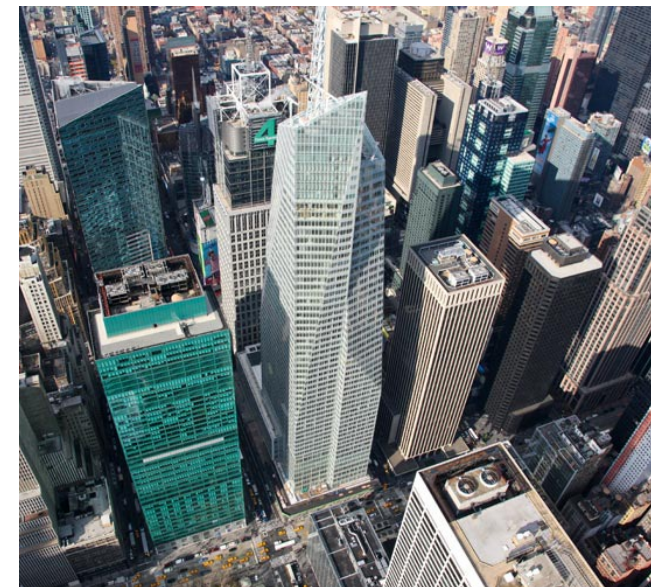

# Low Carbon Retrofits Unlock Climate Progress

NYC: 3 billion square feet of existing office, multifamily buildings

~70% of today's buildings constructed prior to energy code

~90% of today's buildings will still be in operation in 2050

Buildings account for ~45% of NYS energy-related greenhouse gas emissions

## Low Carbon Retrofits: Highlight on NYC Market Opportunity

The mid-range estimate of market opportunity

\$20B

The annual retrofit market will expand by

13x

Number of jobs created across the NYC metro area by 2030

141K

Source: Urban Green Council, Retrofit Market Analysis 2019

# Low Carbon Playbooks

In 2020, Vornado, The Durst Organization, Hines and Empire State Realty Trust partnered with NYSERDA to conduct in-depth analysis of their buildings.

The animating question is: **What are the retrofit pathways that transition this building to carbon neutrality and are economically and technically viable?**

What follows is the answer from the Hines team.

# Playbook Partner

**HUDSON  
SQUARE  
PROPERTIES**

# HUDSON SQUARE PROPERTIES

TRINITY CHURCH  
WALL STREET

Hines



NORGES BANK  
INVESTMENT MANAGEMENT

Established in 2015, Hudson Square Properties (HSP) is a joint venture of Trinity Church Wall Street, Norges Bank Investment Management and Hines. Together, Hudson Square Properties owns and manages a 12-building portfolio of approximately 6 million square feet in lower Manhattan.

Hines is a privately owned global real estate investment firm founded in 1957 with a presence in 285 cities in 28 countries. Hines oversees investment assets under management totaling approximately \$90.3 billion<sup>1</sup>. In addition, Hines provides third-party property-level services to 373 properties totaling 114.2 million square feet. Historically, Hines has developed, redeveloped or acquired approximately 1,530 properties, totaling over 511 million square feet. The firm currently has more than 198 developments underway around the world. With extensive experience in investments across the risk spectrum and all property types, and a foundational commitment to ESG, Hines is one of the largest and most-respected real estate organizations in the world. Visit <http://www.hines.com> for more information.

<sup>1</sup> Includes both the global Hines organization as well as RIA AUM as of December 31, 2021

# Commitment to Carbon Neutrality

- Carbon neutrality elements are currently implemented in the firm's portfolio, most notably at 555 Greenwich, which is forecasted to achieve carbon emissions reductions 45% lower than New York City's 2030 targets for office buildings. The project is also designed to align with a 1.5°C pathway while meeting the state's 2050 carbon neutral targets. It is expected to be one of the most sustainable buildings in the city and is one of Hines' pilot projects in the firm's formative embodied carbon reduction initiative.
- **Hudson Square Properties** has pledged one of its buildings – 345 Hudson – to reach carbon neutrality by 2032.
  - The building will reduce its site Energy Use Intensity (EUI) by 69% from 2010 EUI level by 2032. The EUI of the building in 2010 was 126 kbtu/SF, and by 2032, Hines commits to reduce the EUI to 40 kbtu/SF.
- In 2021, Hines promoted Mike Izzo to Vice President-Carbon Strategy to lead the firm in assessing its global carbon emissions and develop the strategy to set and achieve the firm's science-based targets.

# The Team



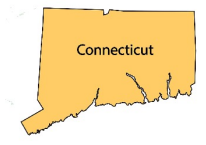

**Edward Gutowski**  
Senior Consultant  
Van Zelm

**Paul Nichilo**  
Sr. VP Operations  
Hunter Roberts



**Anthony DiGirolamo**  
Sr. MEPS Estimator  
Hunter Roberts



**Jonathan Karlsson**  
VP  
URBS



**Alonso Dominguez**  
Sr. Pr. Engineer  
Thornton Tomasetti



**Various Members**  
New Buildings Institute



**Will Sibia**  
VP  
URBS



**Mike Izzo**  
VP  
Carbon Strategy  
Hines



**Colin Schless**  
VP  
Thornton Tomasetti



**Mike Izzo**, Vice President Carbon Strategy in Hines' New York office led the study. He assembled a team comprising experts from:

**URBS | Urban Systems**, a Stockholm, Sweden-based mechanical engineering firm that focuses on sustainable HVAC design

**van Zelm Heywood & Shadford** of Hartford, Connecticut, which specializes in water-based HVAC solutions

**Thornton Tomasetti**, a multi-disciplinary engineering firm known for its advanced building simulation techniques

# Hines' Sustainability Team

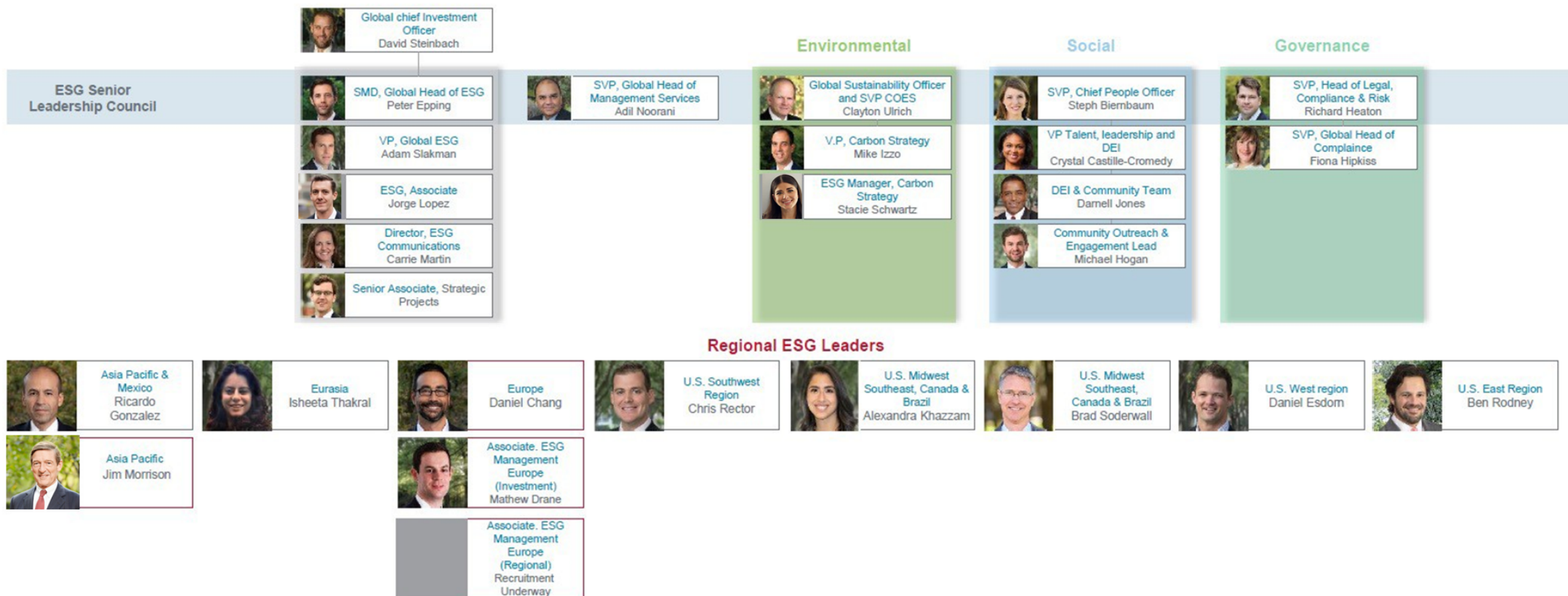

1. Central Operations and Engineering Services

# The Building



# 100 AoA Overview

Built in 1930, the 17-story masonry building structure is representative of many of New York City's commercial buildings.

It has an uninsulated façade, double-pane windows and inefficient heating, cooling and ventilation systems that are prime for replacement.

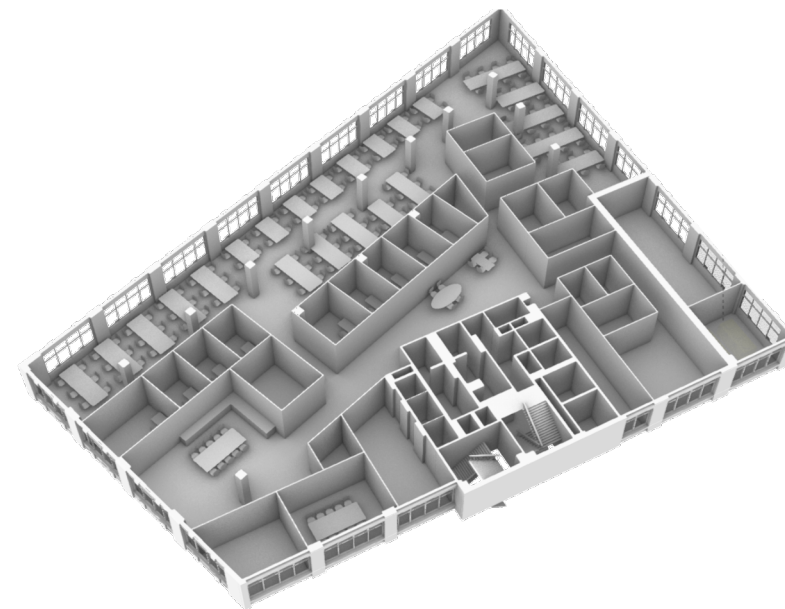

# 100 AoA Energy Attributes

## COOLING

Most floors are cooled by two 30-ton A/C units at a COP of 2.5. Modern units use 20%-60% less energy to provide the same amount of cooling.

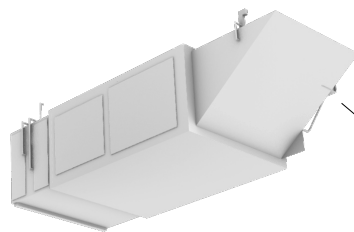

## HEATING

Steam radiators are fed by two 12,00 MBH boilers. These 35 year old units now operate at 65% efficiency, compares to a heat pump which achieves 300% efficiency.

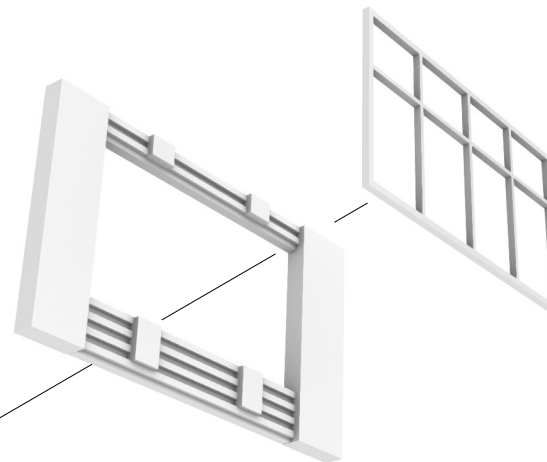
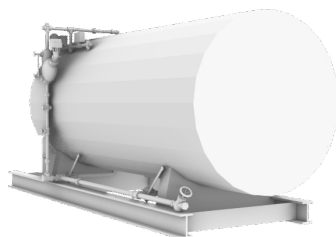

## FAÇADE

Uninsulated masonry façade with 10-year old double-pane windows

# What is the plan to reach carbon neutrality?

## Follow these simple design principles

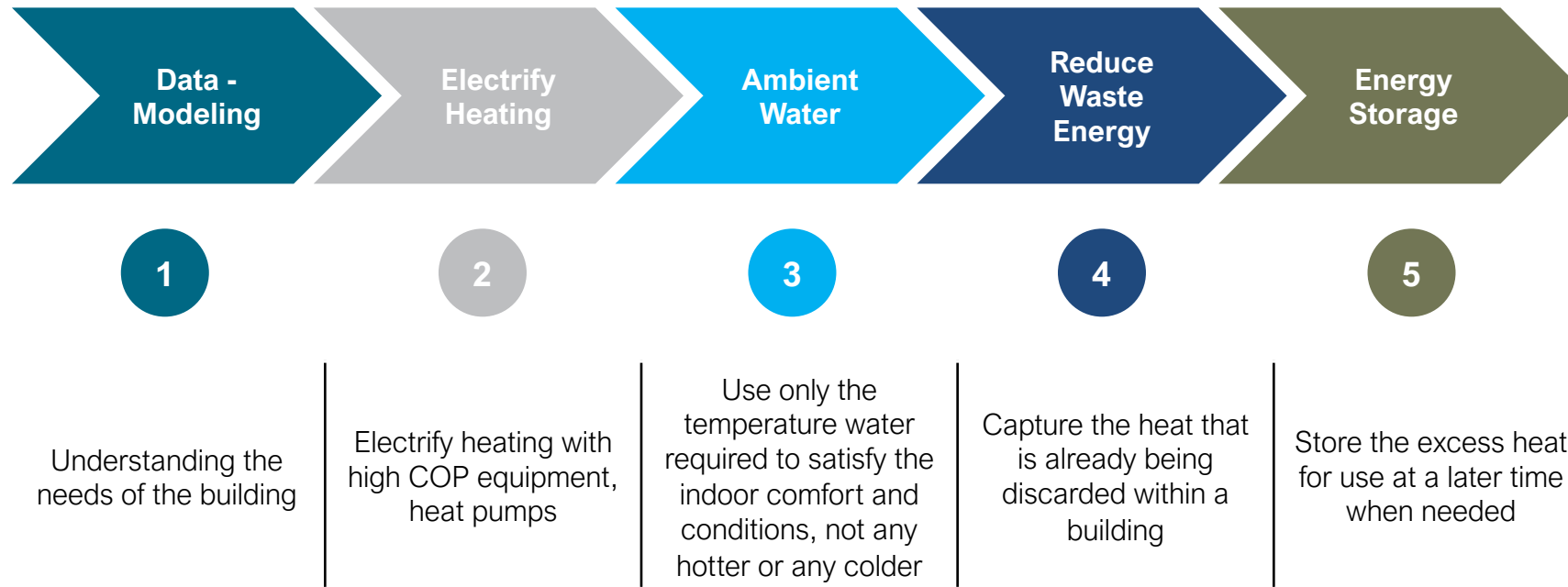

# What is the plan to reach carbon neutrality?

NYC CRREM Pathway Analysis

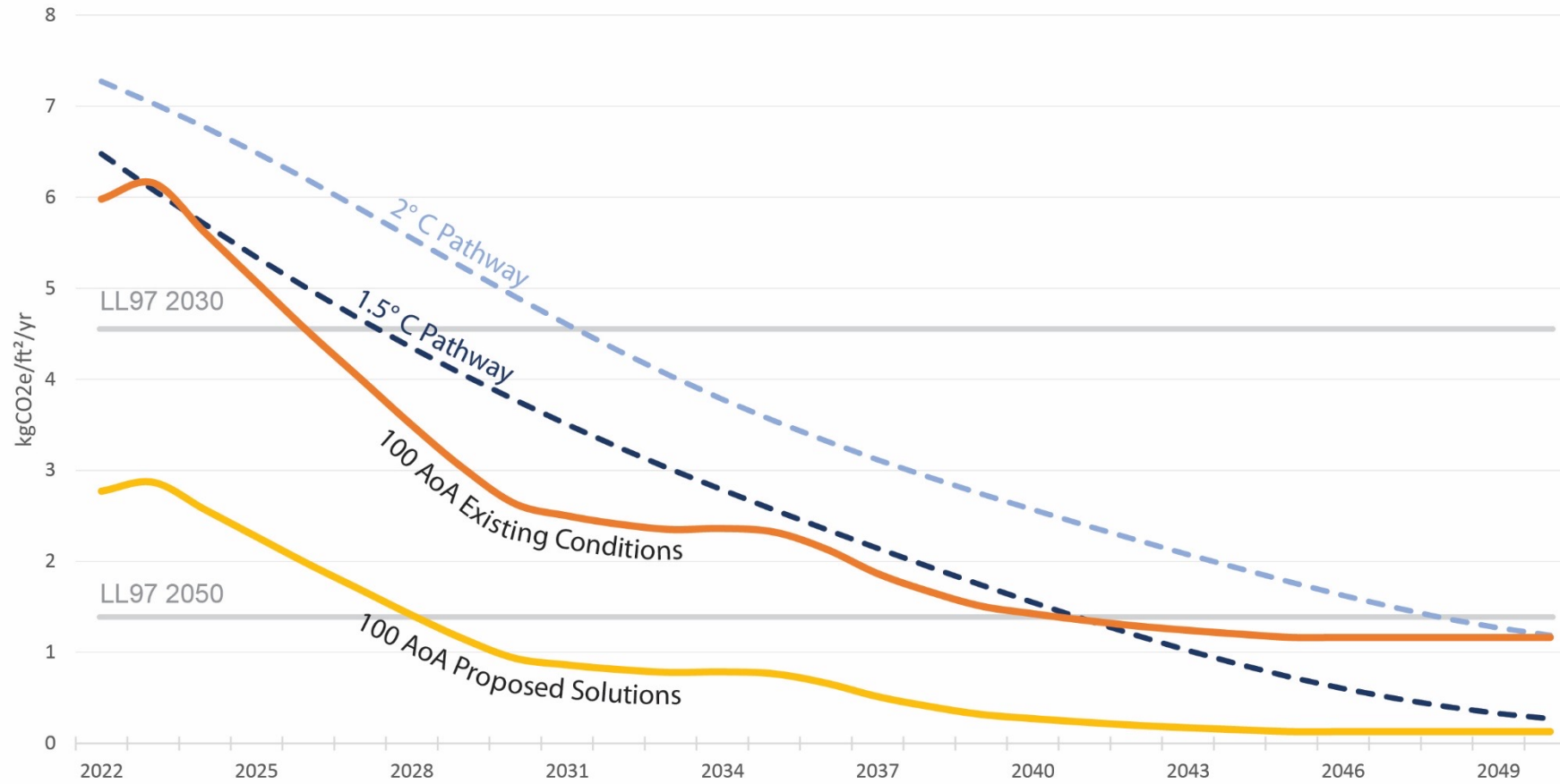

# The Analysis



# Proving that electric-based approaches can work

Until recently the technology to efficiently electrify heating systems hadn't been readily available in the U.S. Using 100 AoA as the test bed, the team set out to prove that electric-based approaches could work.

Three primary solutions were studied:

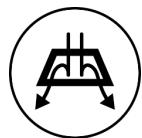

**Active chilled beams with a heat pump**

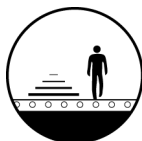

**Active chilled beams, heat pump and radiant floor system**

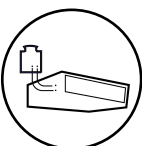

**A hybrid variable refrigerant flow.**

The first two can be built with off-the-shelf parts, while the third, which has been in use in Scandinavia and Japan for more than a decade, will be available in the U.S. within the next year.

# New systems can be phased in over time

Rather than retrofitting the entire building, work can be done on a floor-by-floor basis, which is easier on the budget, allows for greater scheduling flexibility and is less disruptive to existing tenants.

It is estimated that full-floor tenants vacate spaces every 10 to 15 years, providing ample opportunities for upgrades before the city's 2050 deadline.

## TWO SCALES OF REFURBISHMENT

### SINGLE FLOOR RENOVATION



### WHOLE BUILDING RENOVATION

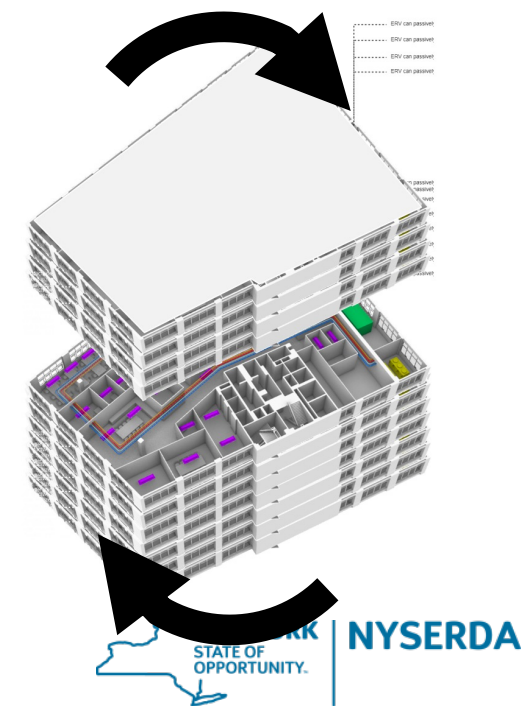

# Energy flows

All three methods rely on a single central heating/cooling machine that can transfer energy between returning hot and cold water streams simultaneously. The machines use a vapor-compression cycle, like that of a residential air conditioning unit, which runs in reverse.

**Rather than cooling a space by pushing heat outdoors, it transfers the heat into another area of the building.**

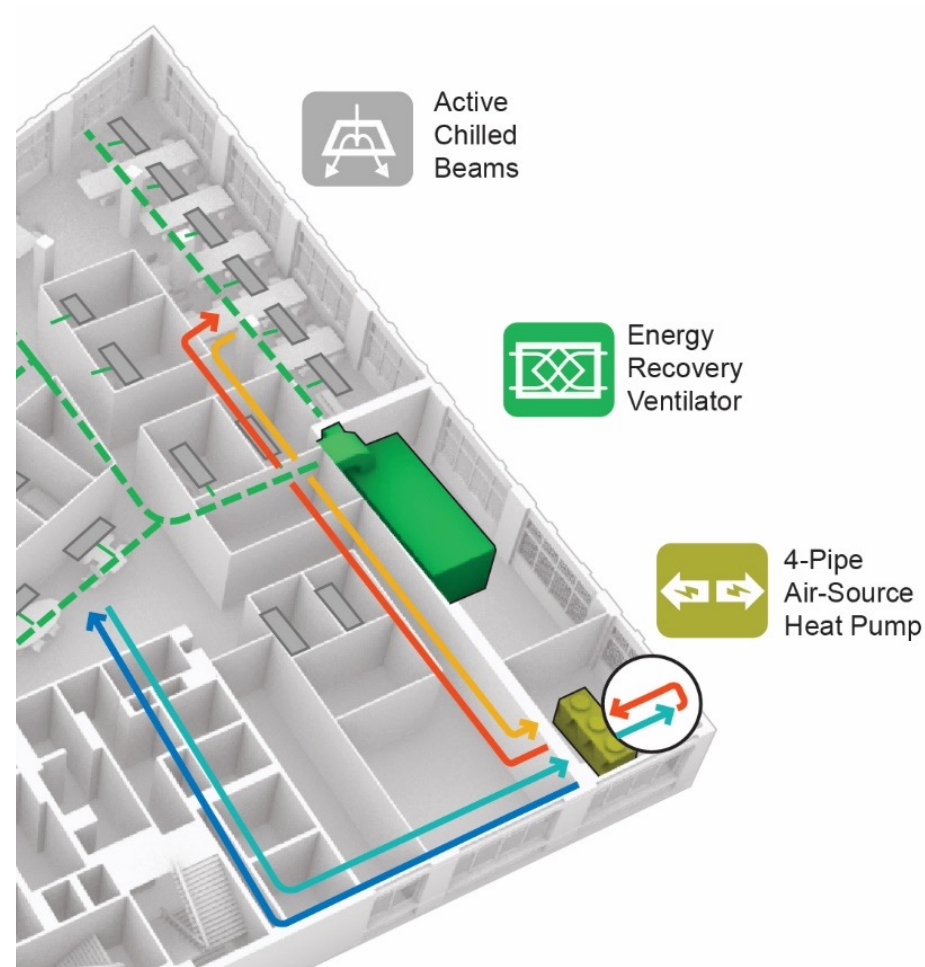

# A more circular approach

Leverage **heat recovery** ventilation to reduce conditioning loads.

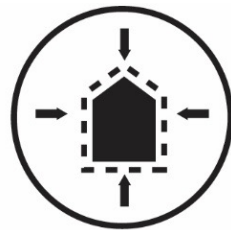

REDUCE  
LOADS

**Recycle** existing sources of heat within the building during the cold weather rather than rejecting it to the atmosphere.



SHARE  
LOADS

Utilize **heat pumps** to satisfy remaining heating loads in buildings and fully eliminate the use of fossil fuel combustion.

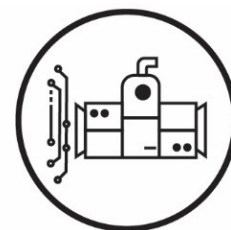

EFFICIENT  
HVAC

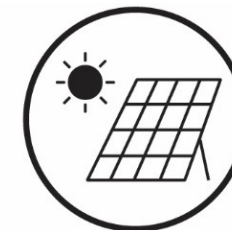

CLEAN  
ENERGY



# SYSTEMS OPTIONS

## BASELINES



FIGURE 4. BOILER #1

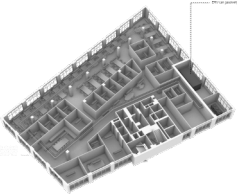

HYBRID VRF

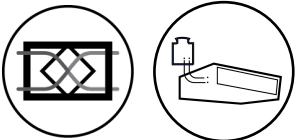

AIR\_SOURCE HEAT PUMP +  
ACTIVE CHILLED BEAMS

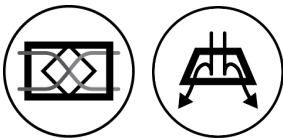

AIR\_SOURCE HEAT PUMP +  
RADIANT SLAB

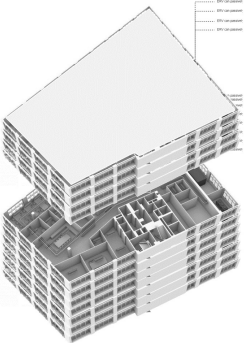
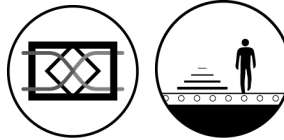

DISTRIBUTED  
WSHP + ACB

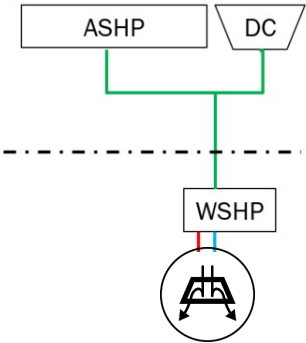

DISTRIBUTED  
WSHP + TAS

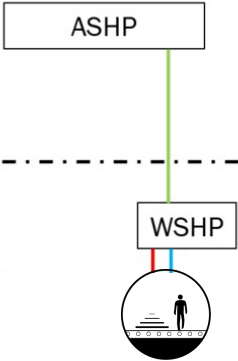

CENTRAL ASHP +  
ACB

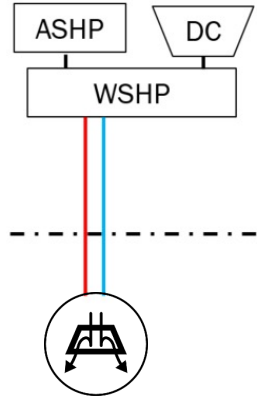

# RESULTS

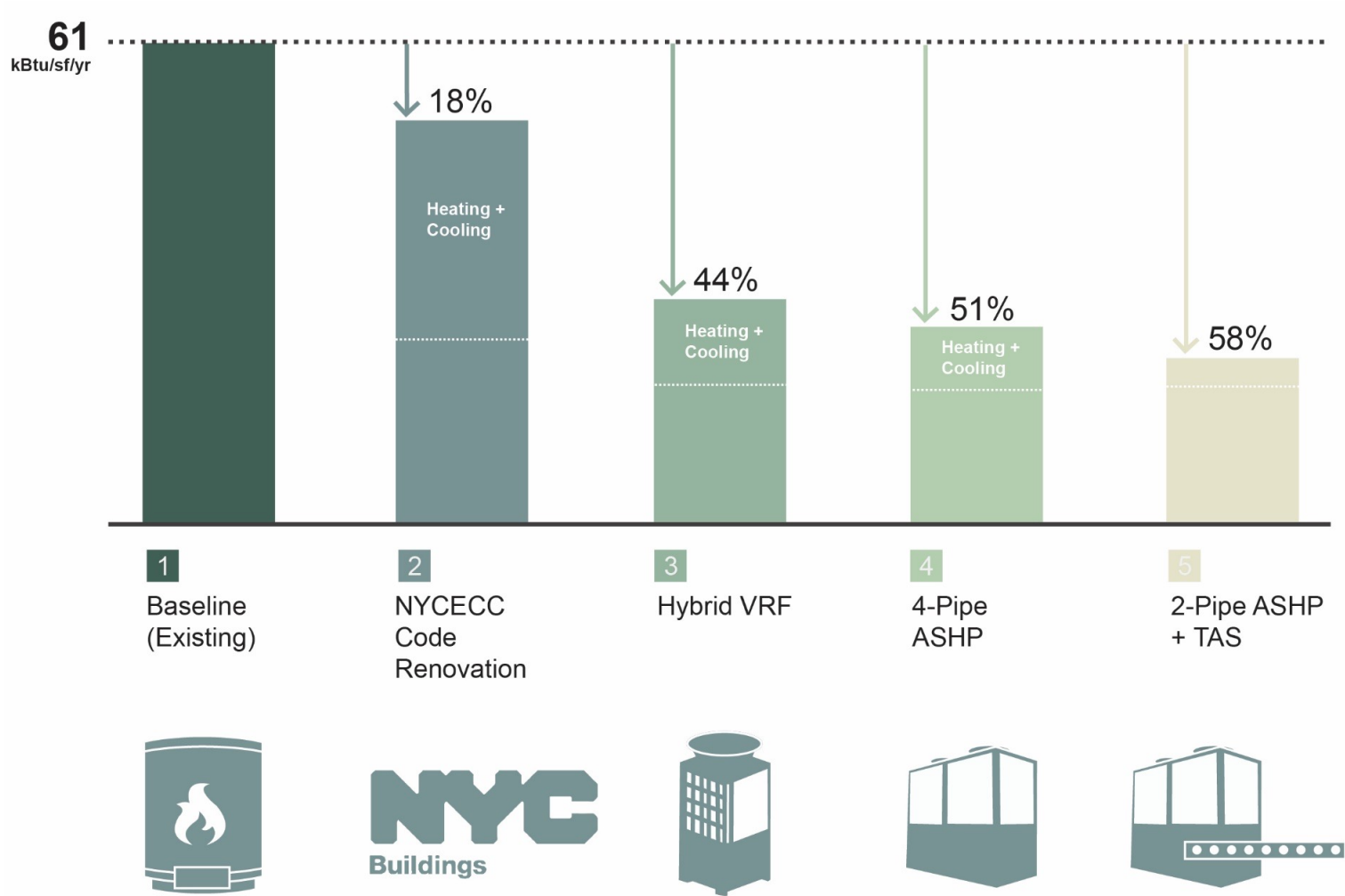

# FIRST COST COMPARISON

HVAC Components (\$/sf)

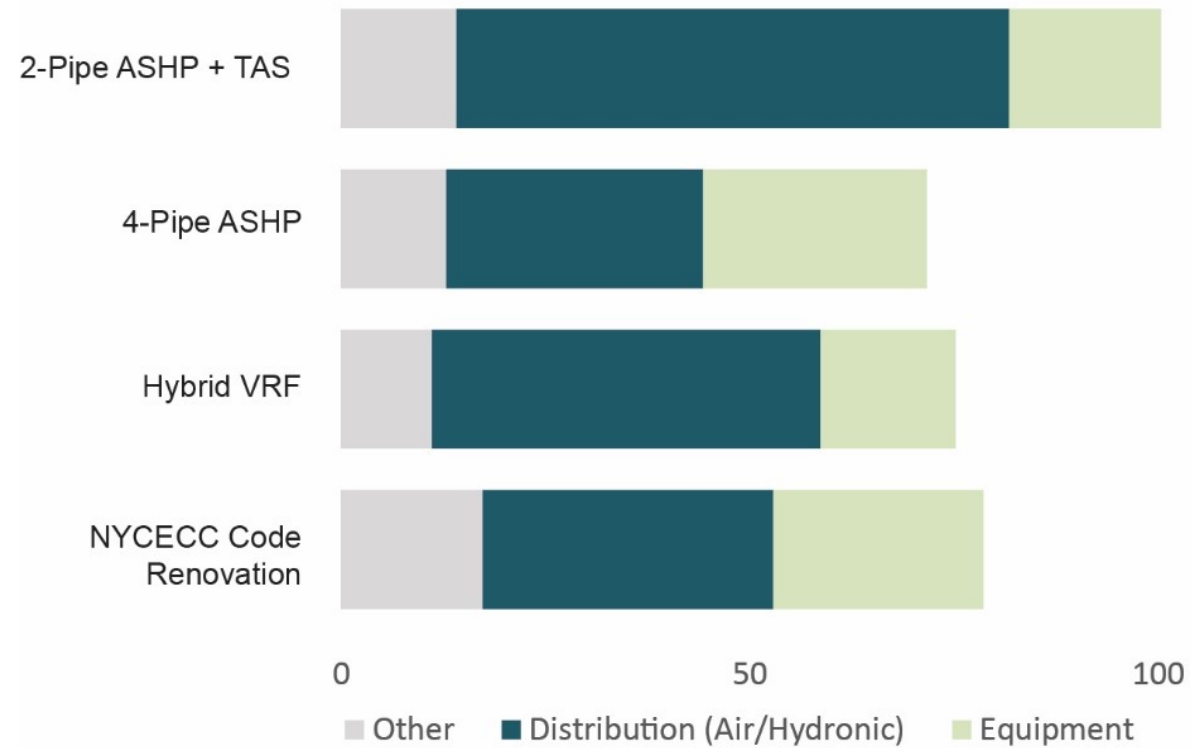



# AMBIENT LOOP

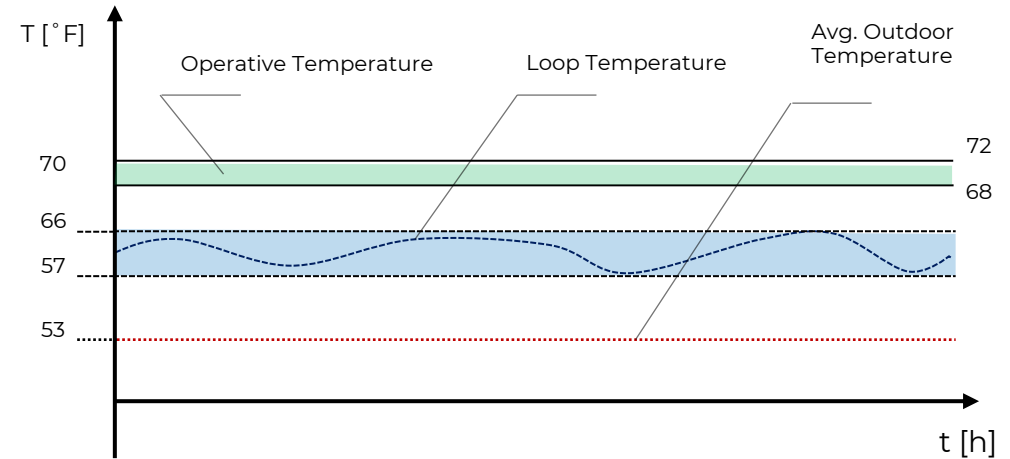
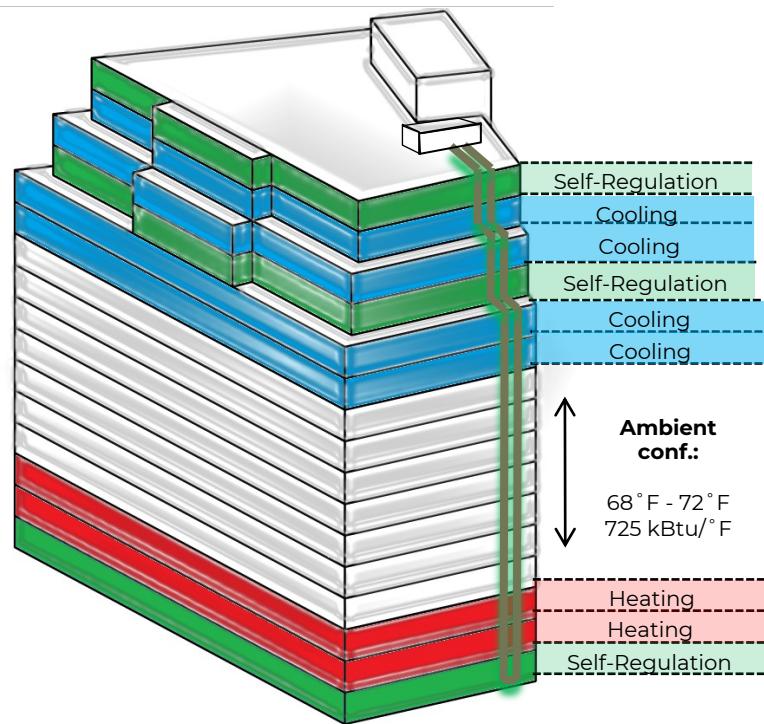

The ambient loop is used as a primary water circulation energy carrier using low temperature variations to keep steady state enthalpy to the sub-sources; heat pumps and chillers.

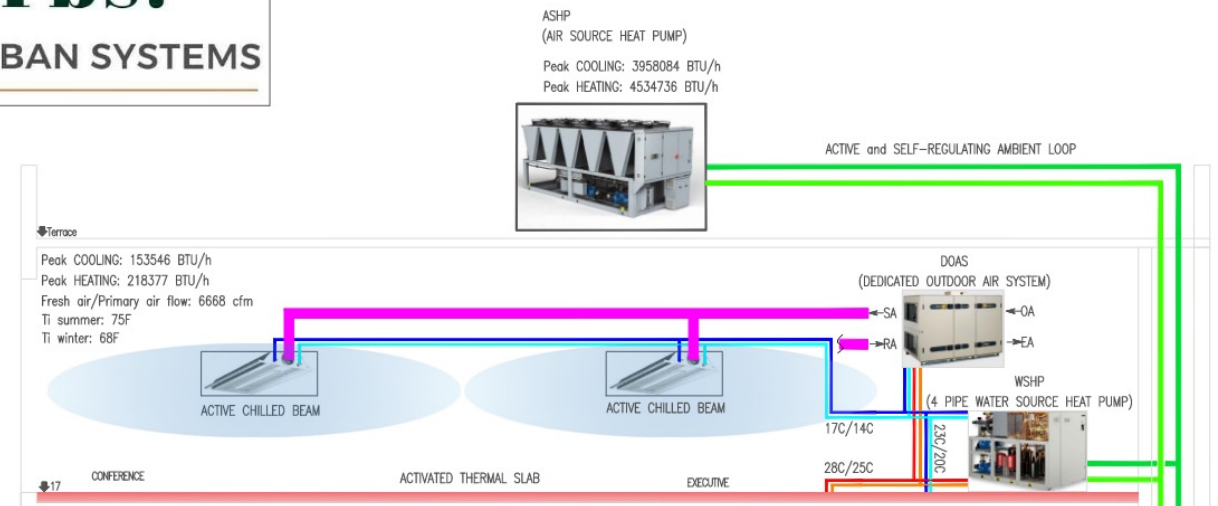

# CARBON FOOTPRINT

WINTER DAY

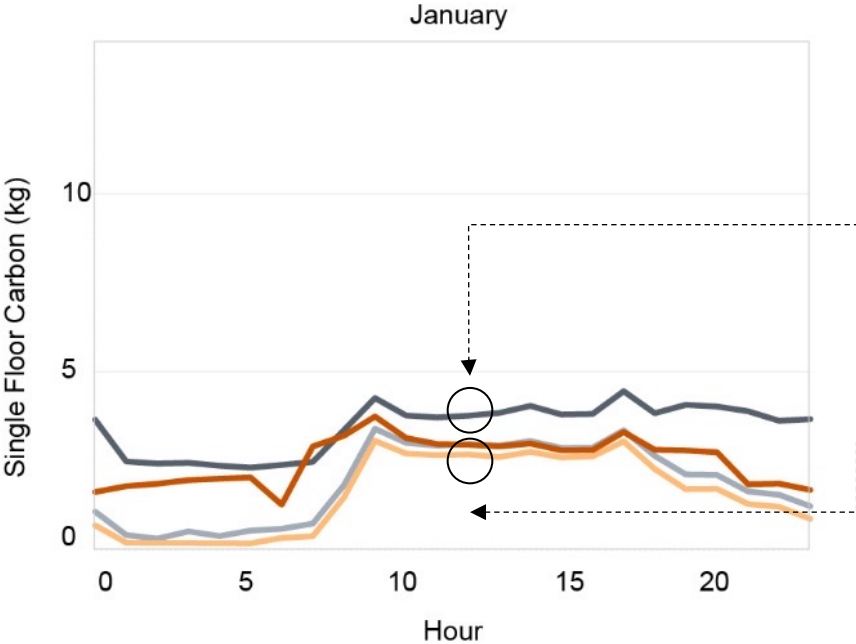

SUMMER DAY

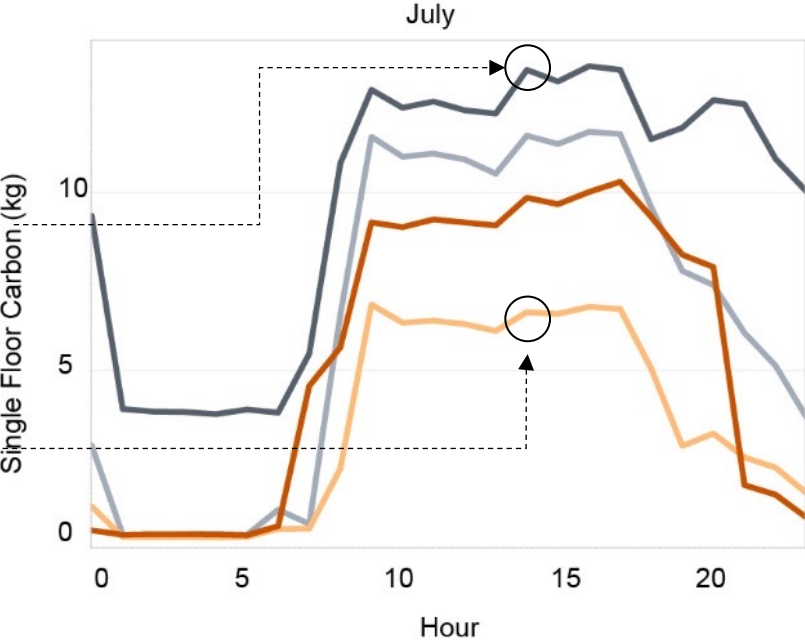

- 4-Pipe ASHP
- 2-Pipe ASHP + TAS
- NYCECC 2020
- Existing

# ELIMINATE FOSSIL FUELS + LOWER EUI

## CURRENT PRACTICE

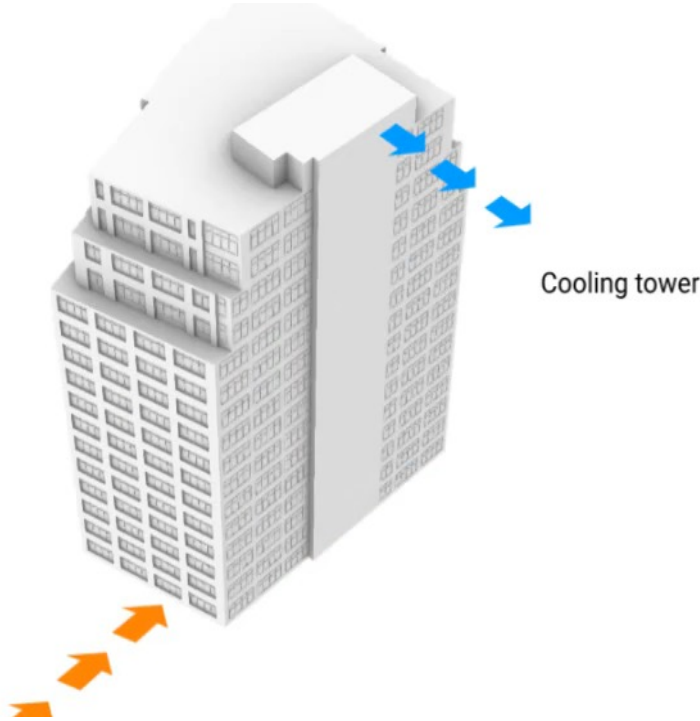

## CURRENT OPPORTUNITY

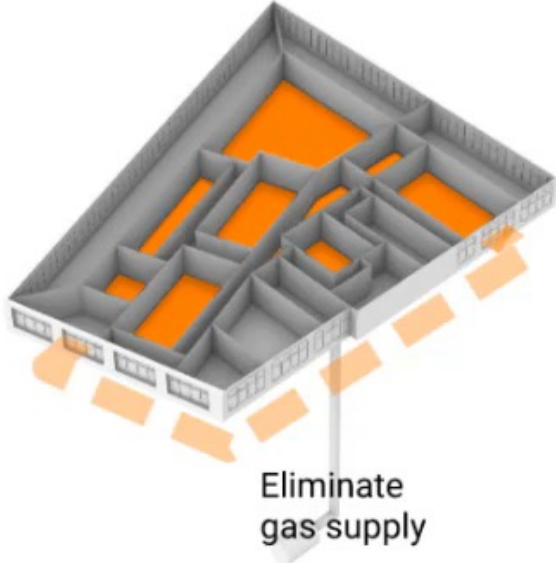

Moving heat from core zones to perimeter zones can eliminate the need for heating during most of year

# Additional Technical Information

# Strategy

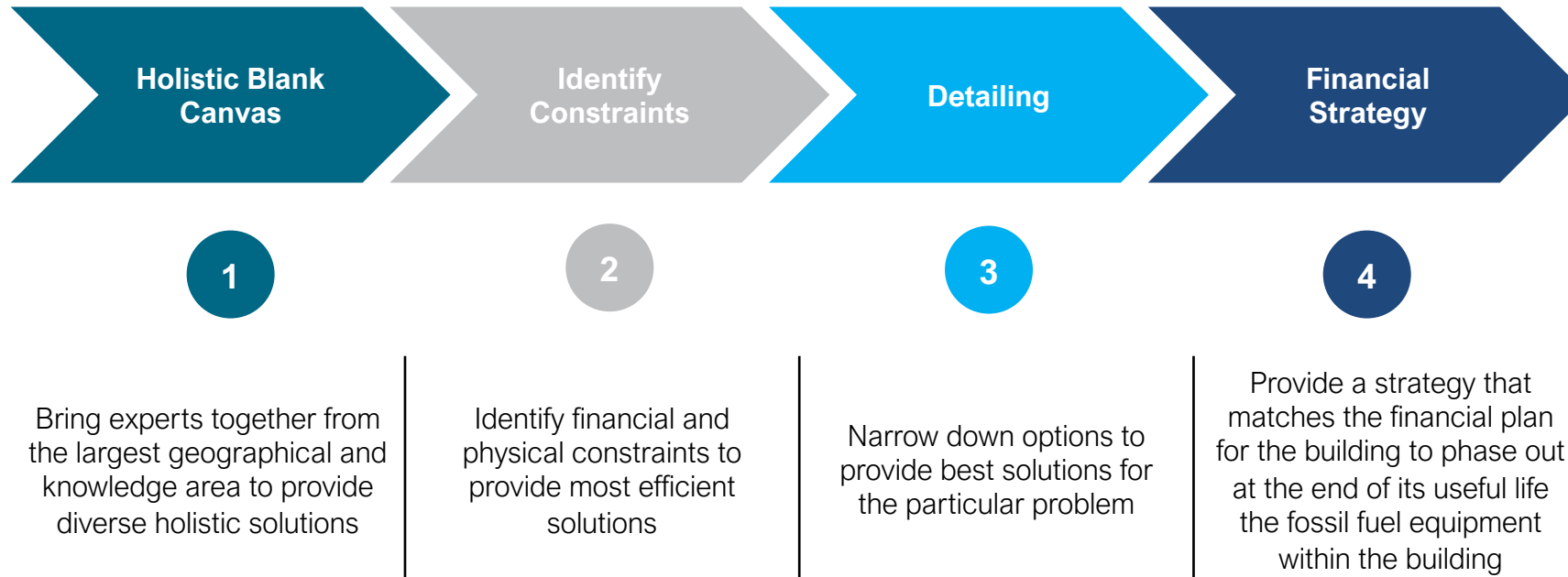

# Analysis Process: 100 AoA

- Established decarbonization goals and timeline
- Assessed existing conditions
- Developed calibrated energy model
- Aligned on objectives
- Designed & iterated
- Prioritized measures/packages
- Conducted financial analysis
- Re-prioritization
- Further analysis plus refinement . . . Iterate.

# DESIGN PROCESS

5 HVAC CHARETTES

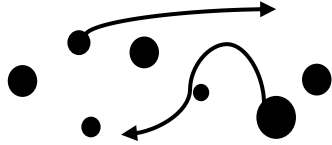

**Full Design  
Simulation  
Pricing**

OF

- 9** Plant options
- 9** Distribution options
- 3** ventilation schemes
- 3** dehumidification options

# 2010 - 2021 NYC Weather Data

2010-2020 NYC Temperature

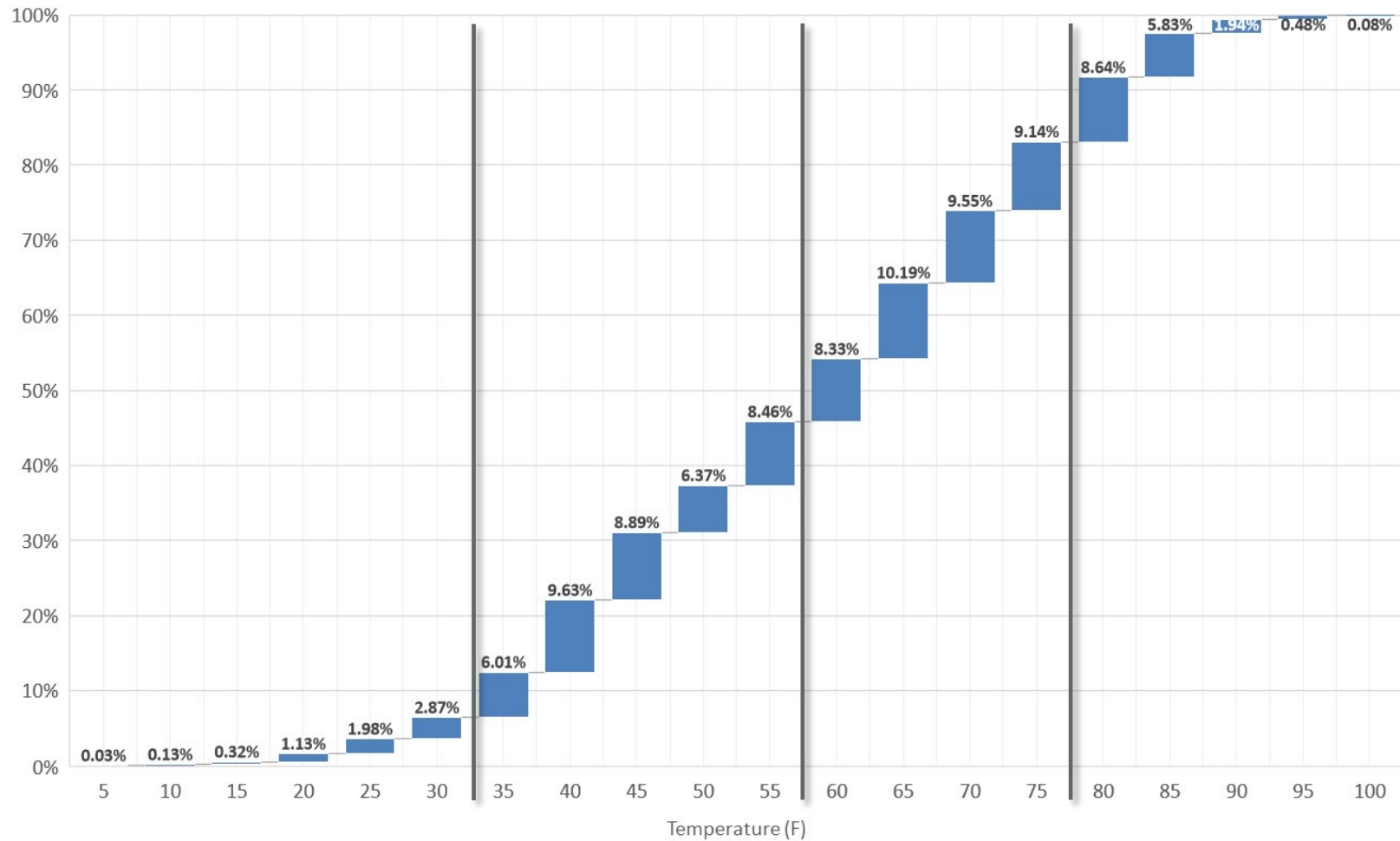

- Building systems and system architecture **shall exploit part load design**, not peak design
  - **Peak heating** (0°F – 29°F) – **6.5%** (5°F - 36 hours, 10°F 143 hours, 15°F 343 hours out of 108,120)
  - **Heating + Cooling** (30°F – 59°F) – **48%**
  - **Moderate Cooling** (60°F – 79°F) – **37.5%**
  - **Cooling** (80°F – 100°F) – **8%**



# PARAMETRIC STUDIES

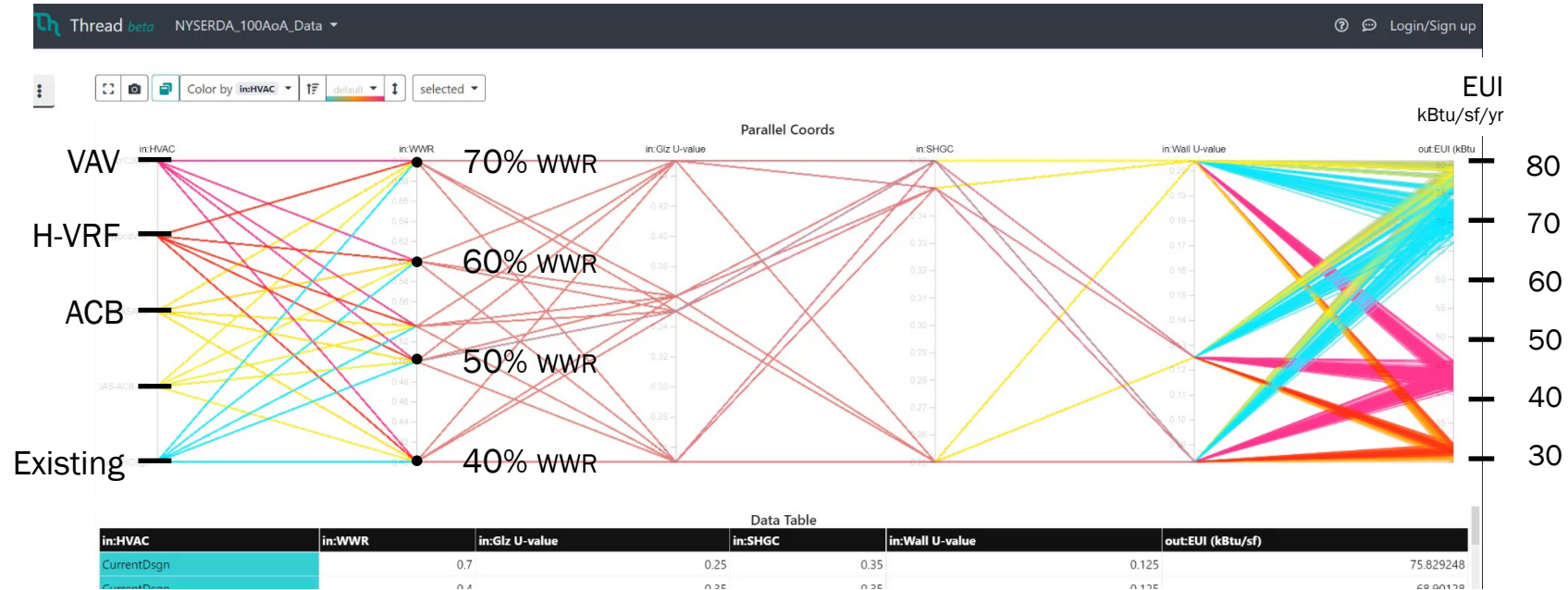

# ANNUAL ENERGY USE BREAKDOWN

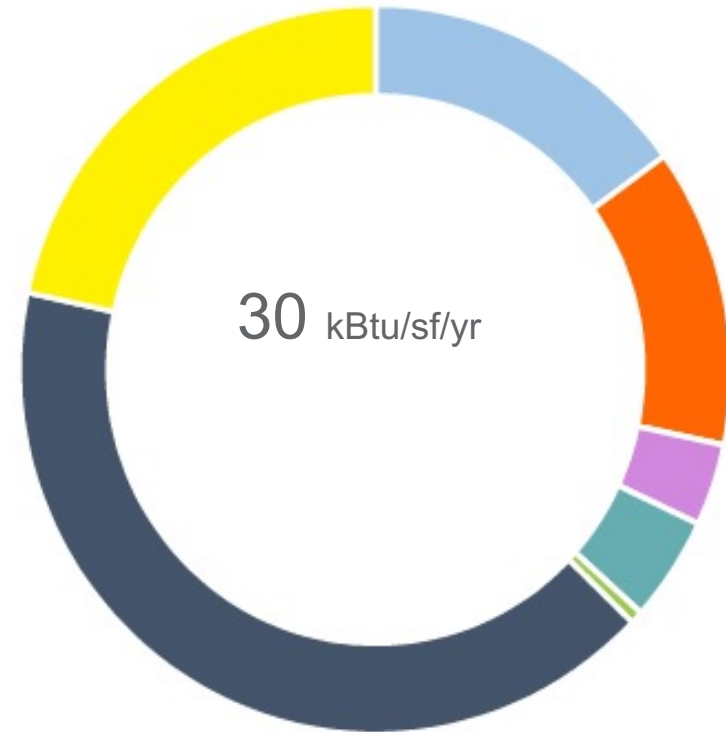

100 AoA ENERGY END-USE

- Cooling
- Heating
- Service Hot Water
- Fans
- Pumps
- Equipment
- Lights

# HEATING

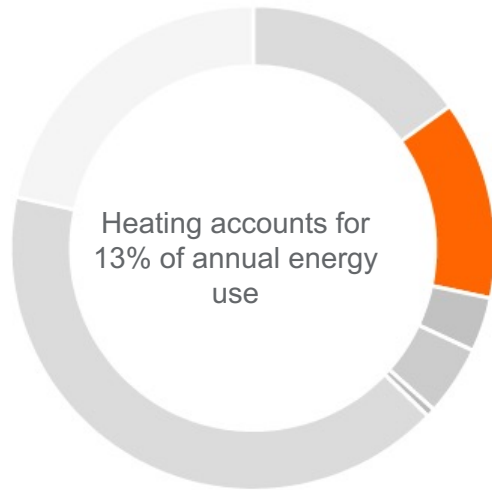

100 AoA ENERGY END-USE

- Cooling
- Heating**
- Service Hot Water
- Fans
- Pumps
- Equipment
- Lights

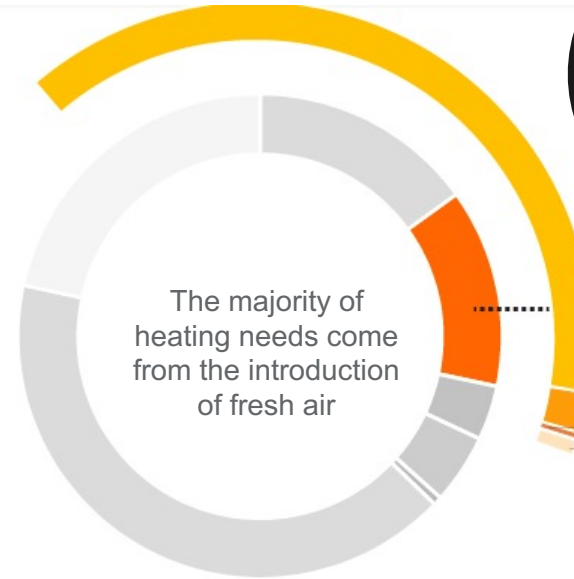

100 AoA ENERGY END-USE

- Cooling
- Heating**
- Service Hot Water
- Fans
- Pumps
- Equipment
- Lights

**( PEAK HEATING )**

Ventilation

Infiltration  
Opaque wall  
Windows

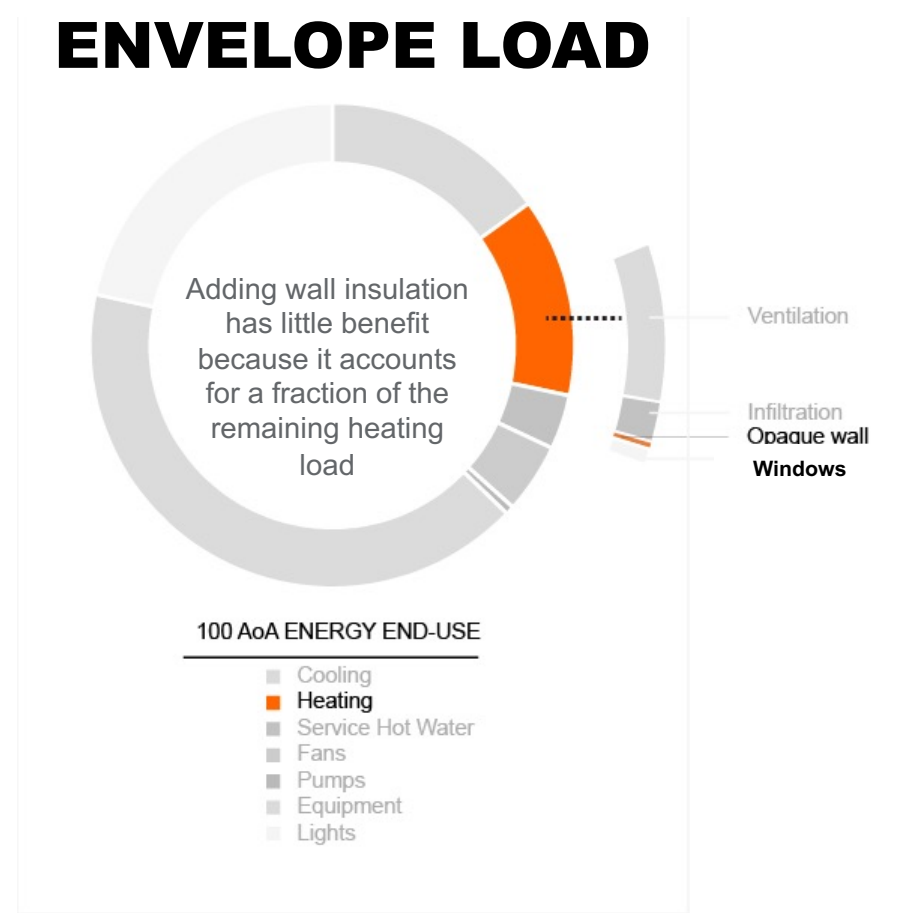
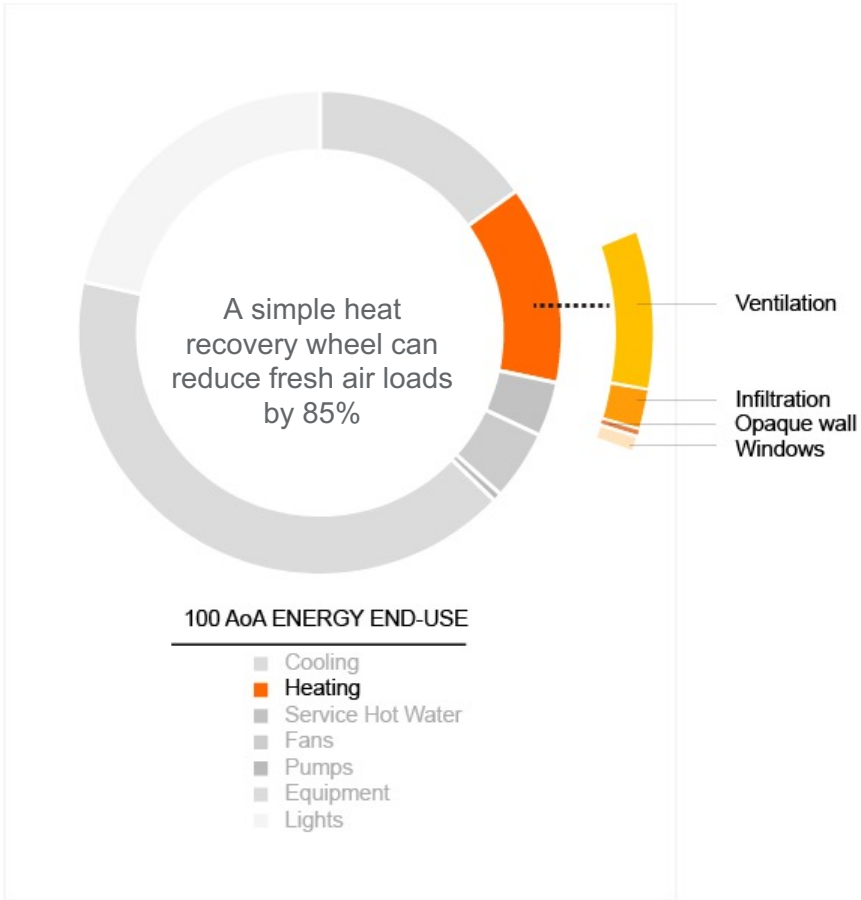

# How did the team conduct this analysis?

## FOCUS ON ENERGY FLOWS.

The fundamental principle of this project was a deep examination into the **energy flows** within commercial office spaces. While lights provide illuminance, they also give off heat. Office equipment and occupants behave much in the same way- they are essential dynamic components within the building program and have a thermal signature that a building's heating and cooling systems must respond to. The analysis was based on examining opportunities to **reuse/recycle/balance these flows** via hydronic-based HVAC retrofits at multiple scales of renovation.